

## 32-Zone Wireless Transceiver Control Panel

### MG5000



MG32LED



MG32LRF



MG10LEDH



MG10LEDV

## User Guide

We hope this product performs to your complete satisfaction. Should you have any questions or comments, please visit [www.paradox.com](http://www.paradox.com) and send us your comments.

# User Settings

For security reasons, write only the user's name and not his or her access code. 4-Digit Codes  6-Digit Codes

User # and Name	Partition 1 or 2	Byp	Stay	Force	Arm Only	PGM Only	Duress
001: Master_____	1 & 2	<input checked="" type="checkbox"/>	<input checked="" type="checkbox"/>	<input checked="" type="checkbox"/>			
002: Master1_____	1	<input checked="" type="checkbox"/>	<input checked="" type="checkbox"/>	<input checked="" type="checkbox"/>			
003: Master2_____	2	<input checked="" type="checkbox"/>	<input checked="" type="checkbox"/>	<input checked="" type="checkbox"/>			
004: _____	___	<input type="checkbox"/>	<input type="checkbox"/>	<input type="checkbox"/>	<input type="checkbox"/>	<input type="checkbox"/>	Duress: Y <input type="checkbox"/> N <input type="checkbox"/>
005: _____	___	<input type="checkbox"/>	<input type="checkbox"/>	<input type="checkbox"/>	<input type="checkbox"/>	<input type="checkbox"/>	Duress: Y <input type="checkbox"/> N <input type="checkbox"/>
006: _____	___	<input type="checkbox"/>	<input type="checkbox"/>	<input type="checkbox"/>	<input type="checkbox"/>	<input type="checkbox"/>	Duress: Y <input type="checkbox"/> N <input type="checkbox"/>
007: _____	___	<input type="checkbox"/>	<input type="checkbox"/>	<input type="checkbox"/>	<input type="checkbox"/>	<input type="checkbox"/>	Duress: Y <input type="checkbox"/> N <input type="checkbox"/>
008: _____	___	<input type="checkbox"/>	<input type="checkbox"/>	<input type="checkbox"/>	<input type="checkbox"/>	<input type="checkbox"/>	Duress: Y <input type="checkbox"/> N <input type="checkbox"/>
009: _____	___	<input type="checkbox"/>	<input type="checkbox"/>	<input type="checkbox"/>	<input type="checkbox"/>	<input type="checkbox"/>	Duress: Y <input type="checkbox"/> N <input type="checkbox"/>
010: _____	___	<input type="checkbox"/>	<input type="checkbox"/>	<input type="checkbox"/>	<input type="checkbox"/>	<input type="checkbox"/>	Duress: Y <input type="checkbox"/> N <input type="checkbox"/>
011: _____	___	<input type="checkbox"/>	<input type="checkbox"/>	<input type="checkbox"/>	<input type="checkbox"/>	<input type="checkbox"/>	Duress: Y <input type="checkbox"/> N <input type="checkbox"/>
012: _____	___	<input type="checkbox"/>	<input type="checkbox"/>	<input type="checkbox"/>	<input type="checkbox"/>	<input type="checkbox"/>	Duress: Y <input type="checkbox"/> N <input type="checkbox"/>
013: _____	___	<input type="checkbox"/>	<input type="checkbox"/>	<input type="checkbox"/>	<input type="checkbox"/>	<input type="checkbox"/>	Duress: Y <input type="checkbox"/> N <input type="checkbox"/>
014: _____	___	<input type="checkbox"/>	<input type="checkbox"/>	<input type="checkbox"/>	<input type="checkbox"/>	<input type="checkbox"/>	Duress: Y <input type="checkbox"/> N <input type="checkbox"/>
015: _____	___	<input type="checkbox"/>	<input type="checkbox"/>	<input type="checkbox"/>	<input type="checkbox"/>	<input type="checkbox"/>	Duress: Y <input type="checkbox"/> N <input type="checkbox"/>
016: _____	___	<input type="checkbox"/>	<input type="checkbox"/>	<input type="checkbox"/>	<input type="checkbox"/>	<input type="checkbox"/>	Duress: Y <input type="checkbox"/> N <input type="checkbox"/>
017: _____	___	<input type="checkbox"/>	<input type="checkbox"/>	<input type="checkbox"/>	<input type="checkbox"/>	<input type="checkbox"/>	Duress: Y <input type="checkbox"/> N <input type="checkbox"/>
018: _____	___	<input type="checkbox"/>	<input type="checkbox"/>	<input type="checkbox"/>	<input type="checkbox"/>	<input type="checkbox"/>	Duress: Y <input type="checkbox"/> N <input type="checkbox"/>
019: _____	___	<input type="checkbox"/>	<input type="checkbox"/>	<input type="checkbox"/>	<input type="checkbox"/>	<input type="checkbox"/>	Duress: Y <input type="checkbox"/> N <input type="checkbox"/>
020: _____	___	<input type="checkbox"/>	<input type="checkbox"/>	<input type="checkbox"/>	<input type="checkbox"/>	<input type="checkbox"/>	Duress: Y <input type="checkbox"/> N <input type="checkbox"/>
021: _____	___	<input type="checkbox"/>	<input type="checkbox"/>	<input type="checkbox"/>	<input type="checkbox"/>	<input type="checkbox"/>	Duress: Y <input type="checkbox"/> N <input type="checkbox"/>
022: _____	___	<input type="checkbox"/>	<input type="checkbox"/>	<input type="checkbox"/>	<input type="checkbox"/>	<input type="checkbox"/>	Duress: Y <input type="checkbox"/> N <input type="checkbox"/>
023: _____	___	<input type="checkbox"/>	<input type="checkbox"/>	<input type="checkbox"/>	<input type="checkbox"/>	<input type="checkbox"/>	Duress: Y <input type="checkbox"/> N <input type="checkbox"/>
024: _____	___	<input type="checkbox"/>	<input type="checkbox"/>	<input type="checkbox"/>	<input type="checkbox"/>	<input type="checkbox"/>	Duress: Y <input type="checkbox"/> N <input type="checkbox"/>
025: _____	___	<input type="checkbox"/>	<input type="checkbox"/>	<input type="checkbox"/>	<input type="checkbox"/>	<input type="checkbox"/>	Duress: Y <input type="checkbox"/> N <input type="checkbox"/>
026: _____	___	<input type="checkbox"/>	<input type="checkbox"/>	<input type="checkbox"/>	<input type="checkbox"/>	<input type="checkbox"/>	Duress: Y <input type="checkbox"/> N <input type="checkbox"/>
027: _____	___	<input type="checkbox"/>	<input type="checkbox"/>	<input type="checkbox"/>	<input type="checkbox"/>	<input type="checkbox"/>	Duress: Y <input type="checkbox"/> N <input type="checkbox"/>
028: _____	___	<input type="checkbox"/>	<input type="checkbox"/>	<input type="checkbox"/>	<input type="checkbox"/>	<input type="checkbox"/>	Duress: Y <input type="checkbox"/> N <input type="checkbox"/>
029: _____	___	<input type="checkbox"/>	<input type="checkbox"/>	<input type="checkbox"/>	<input type="checkbox"/>	<input type="checkbox"/>	Duress: Y <input type="checkbox"/> N <input type="checkbox"/>
030: _____	___	<input type="checkbox"/>	<input type="checkbox"/>	<input type="checkbox"/>	<input type="checkbox"/>	<input type="checkbox"/>	Duress: Y <input type="checkbox"/> N <input type="checkbox"/>
031: _____	___	<input type="checkbox"/>	<input type="checkbox"/>	<input type="checkbox"/>	<input type="checkbox"/>	<input type="checkbox"/>	Duress: Y <input type="checkbox"/> N <input type="checkbox"/>
032: _____	___	<input type="checkbox"/>	<input type="checkbox"/>	<input type="checkbox"/>	<input type="checkbox"/>	<input type="checkbox"/>	Duress: Y <input type="checkbox"/> N <input type="checkbox"/>

# Master Quick Menus

## User

Step	Action	Details
1	[⏻] + [MASTER CODE]	The [⏻] key will flash. LED/key on = programmed user. [PARTITION MASTER CODE] may also be used.
2	[USER NUMBER]	MG32LRF/MG32LED = 2 digits: 01 to 32 MG10LEDV/H = 1 digit: 1 to 0(10)
3	[CODE]	Enter 4- or 6-digit code.
4	[CONFIRM CODE]	Re-enter 4- or 6-digit code.
5	[LEARN REMOTE] / [ENTER]	Press a button on the designated remote or [ENTER] to skip. Goes to the next available user, or if partitioned, go to step 6.
6	[1] and/or [2] + [ENTER]	Assign the user to one or both partitions and press [ENTER]. By default, users are assigned to partition 1. Goes to next available user.
Notes	By default: User 1 has access to both partitions, User 2 has access to partition 1 only, and User 3 has access to partition 2 only. These settings cannot be modified.	

## Delays

Step	Action	Details
1	[⏻] + [MASTER CODE]	The [⏻] key will flash. [PARTITION MASTER CODE] may also be used.
2	[TBL]	
3	[1] = Entry Delay 1 (sec.) [2] = Entry Delay 2 (sec.) [3] = Exit Delay (sec.) [4] = Bell Cut-Off (min.)	
4	[000] to [255]	Enter a value between 000 and 255 (000 = default value).

## Time and Date

Step	Action	Details
1	[⏻] + [MASTER CODE]	The [⏻] key will flash. [PARTITION MASTER CODE] may also be used.
2	[TBL]	
3	[5]	
4	[HH:MM]	Enter time. If HH = 13 or more, skip to step 6.
5	[TIME FORMAT]	Enter time format ([1] = 24hr; [2] = AM; [3] = PM).
6	[YYYY/MM/DD]	Enter date.

## Communicate with WinLoad

Step	Action	Details
1	[⏻] + [MASTER CODE]	The [⏻] key will flash. [PARTITION MASTER CODE] may also be used.
2	[MEM]	
3	[1] = Start communication [2] = Cancel communication	

## Communicator

Step	Action	Details
1	[⏻] + [MASTER CODE]	The [⏻] key will flash. [PARTITION MASTER CODE] may also be used.
2	[MEM]	
3	[3] = Personal Phone #1 [4] = Personal Phone #2 [5] = Personal Phone #3 [6] = Personal Phone #4 [7] = Personal Phone #5 [8] = Pager #	
4	[PHONE #] + [ENTER]	Enter phone # (up to 32 digits) and press [ENTER]. Goes to next phone#, or go to step 5 if [8] = Pager # was selected.
5	[MESSAGE] + [ENTER]	Step 5 for Pager # only. Enter pager message and press [ENTER].

## Test Report

Step	Action	Details
1	[⏻] + [MASTER CODE]	The [⏻] key will flash. [PARTITION MASTER CODE] may also be used.
2	[MEM]	
3	[2]	Send a test report to the monitoring station.

## Auto Arm

Step	Action	Details
1	[⏻] + [MASTER CODE]	The [⏻] key will flash. [PARTITION MASTER CODE] may also be used.
2	[BYP]	
3	[1] = Auto arm (partition 1) [2] = Auto arm (partition 2)	
4	[HH:MM]	Enter time (24Hr clock).
5	[1] = Regular arm [2] = Sleep arm [3] = Stay arm	

## Erase Lost Remote Controls

Step	Action	Details
1	[⏻] + [MASTER CODE]	The [⏻] key will flash. [PARTITION MASTER CODE] may also be used.
2	[BYP]	
3	[3]	
4	[ALL REMOTES] + [ENTER]	Press a button on all remotes. Press [ENTER].
5	Press and hold [SLEEP] (3sec)	Press and hold [SLEEP] to erase all lost remotes.

## System Options

Step	Action	Details
1	[⏻] + [MASTER CODE]	The [⏻] key will flash. [PARTITION MASTER CODE] may also be used.
2	[BYP]	
3	[4] = Regular arm [5] = Sleep arm [6] = Stay arm	Toggle to have the siren squawk on arm/disarm with keypad. Toggle to have the siren squawk on arm/disarm with remote. Toggle to have no exit delay when arming with remote.

# Table of Contents

User Settings .....	0
Master Quick Menus .....	1
<b>Overview .....</b>	<b>4</b>
Basic Operations .....	4
<b>StayD Mode .....</b>	<b>6</b>
To Turn On/Off StayD Mode .....	6
To Change Arm Mode .....	6
Advanced StayD Settings .....	6
<b>Access Codes .....</b>	<b>7</b>
Programming Access Codes .....	7
<b>Arming &amp; Disarming .....</b>	<b>8</b>
Regular Arming .....	8
Sleep Arming .....	8
Stay Arming .....	8
One-Touch Arming .....	9
Auto-Arming .....	10
Disarming & Deactivating an Alarm .....	10
Manual Bypass Programming .....	10
<b>System Features .....</b>	<b>12</b>
Display Mode .....	12
Alarm Display .....	12
Fire Alarms .....	12
Panic Alarms .....	12
Programming Chime Zones .....	13
Keypad Muting .....	13
Keypad Backlight .....	13
PGM Keys (Programmable Outputs) .....	13
Power Save Mode .....	14
Trouble Display .....	14
<b>Advanced Features .....</b>	<b>15</b>
Quick Function Keys .....	15
Testing & Maintenance .....	15
System Checklist .....	16

# Overview

Thank you for selecting the Magellan Security System from Paradox Security Systems Ltd. This advanced technology security system provides you with reliable security protection and powerful features that anyone can use without memorizing complex and confusing codes. The system consists of the Magellan control panel, one or more Magellan keypad modules, various input devices (e.g. motion detectors, door contacts, etc.) and various output devices (e.g. bells, sirens, lights, etc.).

The elegant and user-friendly Magellan MG10LEDV/H, MG32LED, and MG32LRF keypad modules allow you to easily access your security system's functions and provide you with an easy-to-understand display of your security system's alarm and operational status. All of the actions performed in your security system will be executed and displayed through the keypad. Therefore, before using your security system, we highly recommend that you read this manual carefully and have your installer explain basic system operation to you.

## Basic Operations

### Auditory Feedback

When you enter information on the keypad, it will guide you with beep tones that communicate acceptance or rejection of your entries. You should be familiar with these two keypad beep tones:

**Confirmation Beep:** When an operation (e.g. arming/disarming) is successfully entered on the keypad or when the system switches to a new status/mode, the keypad produces an intermittent beep tone ("BEEP-BEEP-BEEP-BEEP").

**Rejection Beep:** When the system reverts to its previous status or when an operation is incorrectly entered on the keypad, it will emit a continuous beep tone ("BEEEEEEEEEP").

### Visual Feedback

**Keypad Indicator Lights:** All Magellan keypads include coloured lights which convey the current status of your system. The state of each light represents a specific condition in your system.



Many of the features in your system must be enabled by the installer. If the feature is not programmed, the keypad will emit a rejection beep and the action will be cancelled. Refer to System Checklist on page 16 for details.

### Overview of the Magellan Series Keypads

The numbers and keys of the Magellan series keypad's screen communicate your system's status.

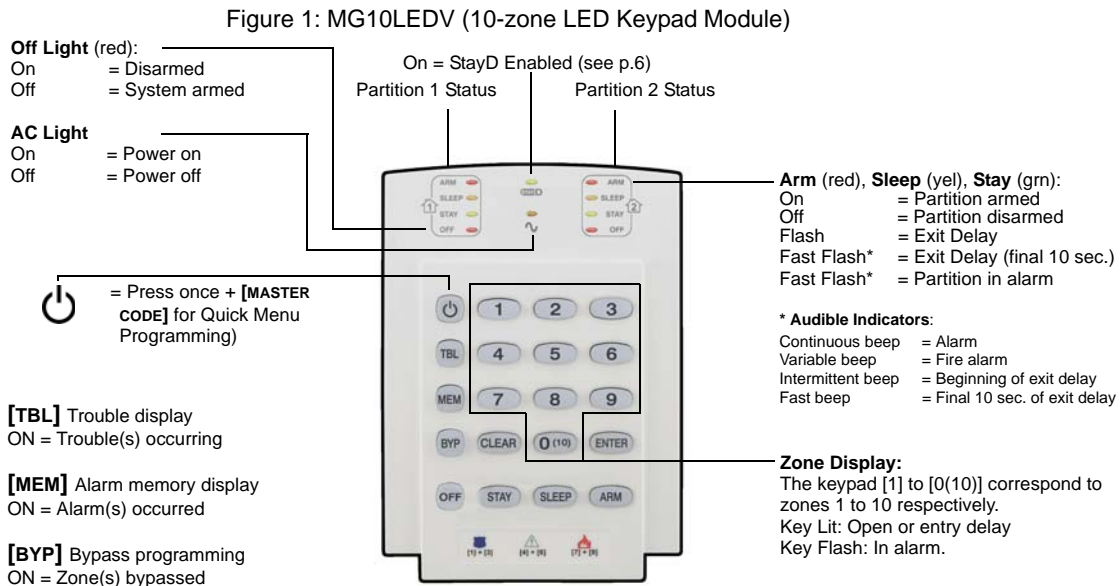

Figure 2: MG32LED (32-zone LED Keypad Module)

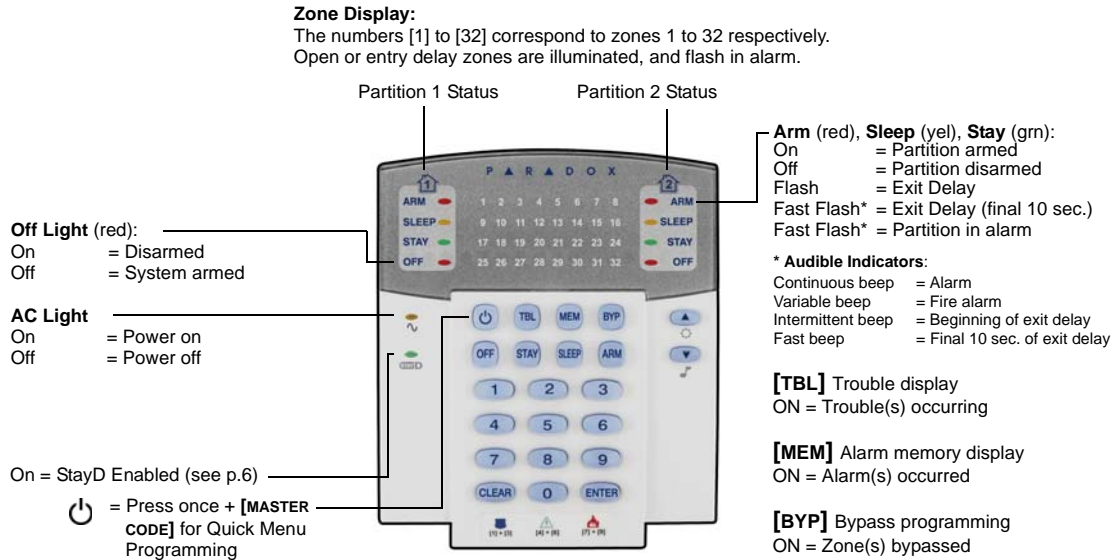
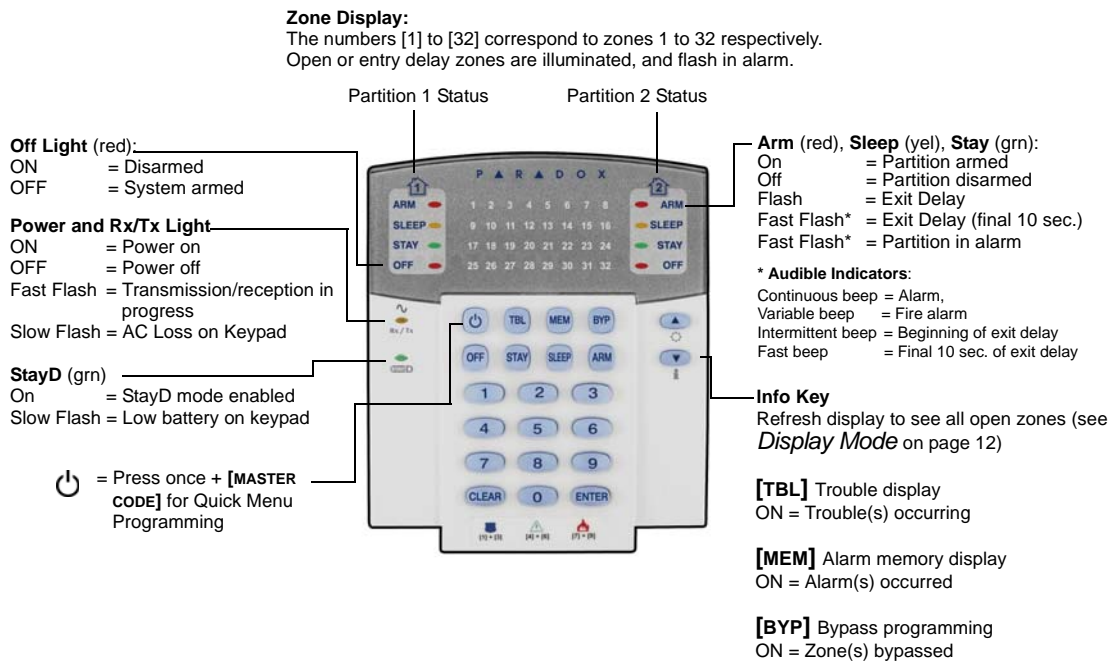

Figure 3: MG32LRF (32-zone Wireless LED Keypad Module)



## Partitioning

Your Magellan system is equipped with a partitioning feature that can divide your alarm system into two distinct areas identified as Partition 1 and Partition 2. Partitioning can be used in installations where shared security systems are more practical, such as a home office or warehouse building. When partitioned, each zone, each user code and many of your system's features can be assigned to either Partition 1, Partition 2, or both partitions.



**If the system is not partitioned, all zones, user codes, and features will be recognized as belonging to Partition 1.**

# StayD Mode

---

## To Turn On/Off StayD Mode

### To turn on StayD mode:

[STAY] + [CODE] + [STAY] → StayD light on

Press the [STAY] key followed by a valid code, then press the [STAY] key again within ten seconds. The StayD light will light up to confirm StayD activation, and the system will be in Stay mode.

### To turn off StayD mode:

[OFF] + [CODE] + [OFF] → Off light on

Press the [OFF] key followed by a valid code, then press the [OFF] key again within ten seconds. The StayD light will turn off and the Off light will light up to confirm StayD deactivation. With StayD disabled, the system will function as a standard security system.

## To Change Arm Mode

### To change the level of security - Stay to Sleep:

[SLEEP] for 2 sec. → Delay → Sleep light on

Press and hold the [SLEEP] key on any keypad. All zones which will be armed in Sleep mode go into exit delay, allowing you to move to the bedroom. When the exit delay ends, and you are in the bedroom, the rest of the interior will arm. The system is now in Sleep mode.

### To change the level of security - Sleep to Stay:

[STAY] for 2 sec. → Stay light on

Press and hold the [STAY] key on the keypad located in the bedroom. The system will instantly switch from Sleep to Stay mode, allowing you to leave the bedroom and move freely inside the house. If you accidentally leave the bedroom without switching to Stay mode, all zones armed in Sleep mode will go into a delay, allowing you enough time to switch to Stay mode.

### Leaving the site - Stay to Full:

Keypad: [ARM] for 2 sec. → Delay → Arm light on

Remote:  on remote

Press and hold the [ARM] key on the keypad that the exit path is assigned to. This will start an exit delay period for all zones in the exit path. After you have left the property, all exit path zones will rearm. The system is now in Full mode.

### Entering the site - Full to Stay:

Keypad: [CODE] → Stay light on

Remote:  on remote

When entering the property through the entry path, all zones assigned to the entry path will go into delay, allowing you to enter the house. Entering a valid code on the keypad the entry path is assigned to ends the entry delay and switches the system to Stay Arm mode. The entry path zones will rearm. The system is now in Stay mode.

### Leaving the site without changing arm mode:

[OFF] for 2 sec.

Press and hold the [OFF] key for 2 seconds on a keypad to leave the site without changing arm mode.

## Advanced StayD Settings

### To open one window/door while inside:

[OFF] → [CODE]

In a Stay-armed system: This mode allows you to open one exterior zone without triggering an alarm. To enter Window mode, press [OFF], then your [ACCESS CODE]. The system will start an exit delay, allowing you to open an exterior zone such as a window or a door. The system will only allow you to open one zone as the exit delay will end after doing so. When you close the open zone (window, door, etc.) that zone will re-arm.

### Live View Mode:

During an alarm, press the [CLEAR] key to view the movement. The zone lights on the keypad will show the opening and closing of zones as they occur.

### Re-arm Delay:

Re-arm Delay is a delay timer set so that when you close the open exterior zone (window, door etc.), it does not re-arm instantly. Instead the system starts a delay to allow you to close the zone properly. This is especially useful for windows that stick or for reducing false alarms.



# Access Codes

## Programming Access Codes

Access codes are personal identification numbers that allow you to enter certain programming modes, arm or disarm your system as well as activate or deactivate PGMs. The Magellan security system supports the following:

- 1 System Master Code
- 2 Master Codes
- 29 User Access Codes

For information on how each access code can arm or disarm the system refer to the *System Checklist* on page 16.

### System Master Code (Default: 123456)

The System Master Code can arm or disarm any partition using any of the methods described in this section and can create, modify or delete any user access code.

### Master Codes

Master Code 1 is permanently assigned to Partition 1 and can be used to create, modify or delete user access codes that are assigned to Partition 1.

Master Code 2 is permanently assigned to Partition 2 (Exception: When partitioning is disabled, Master Code 2 will be assigned to Partition 1) and can be used to create, modify or delete user access codes that are assigned to the same partition.



*Master Codes cannot modify or delete user access codes assigned to both partitions. Only the System Master Code can modify or delete user access codes assigned to both partitions.*

### Duress Code

If you are forced to arm or disarm your system, entering the access code with the duress option enabled will arm or disarm the system and immediately transmit a silent alert (Duress Code) to the monitoring station.



*Must be enabled by your installer.*

## Programming Access Codes

Your system can be programmed to use either 4- or 6-digit access codes, where each digit can be any value from 0 to 9. Six-digit codes are considered more difficult to “crack” and therefore, more secure. Avoid programming simple or obvious access codes, such as your telephone number, address or codes such as 1234. See *Master Quick Menu* on inside cover.

### How do I program Access Codes?

1. Press the **[⏻]** key.
2. Enter your **[SYSTEM MASTER CODE]** or either **[MASTER CODE]**.
3. The **[⏻]** key will flash. When a zone LED or zone key is lit (not flashing), the user is already programmed.
4. Select a user by entering a 2-digit user number (e.g. **[0]+[9]** for user 9) or use the scroll keys and then press **[ENTER]**. For the MG10LEDV/H, press the key corresponding to the user number (e.g. **[9]** for user 9).
5. Enter a new 4- or 6-digit **[ACCESS CODE]**.
6. Confirm the code.
7. Press a button on the designated remote or press **[ENTER]** to skip if there is no remote to program.
8. (Not available for non-partitioned system) Press **[1]** and/or **[2]** to assign the user to a partition. Press **[ENTER]**, the menu will now jump to the next available user, if you choose to continue.

### How do I delete Access Codes?

1. Press the **[⏻]** key.
2. Enter your **[SYSTEM MASTER CODE]** or either **[MASTER CODE]**.
3. Select a user by entering a 2-digit user number (e.g. **[0]+[9]** for user 9). For the MG10LEDV/H, enter a 1-digit user number (e.g. **[9]** for user 9).
4. Press and hold the **[SLEEP]** key until you hear the confirmation beep.

# Arming & Disarming

Take full advantage of your Magellan system by familiarizing yourself with all the arming methods. If your system is not partitioned (see *Partitioning* on page 5), everything is considered as belonging to Partition 1.

 If you cannot arm because a zone is open, the system will enter in Bypass Programming. Enter the two digit zone you wish to bypass and press [ENTER], or press [ENTER] to bypass all open zones.

## Regular Arming

This method will arm all the zones in the selected partition. Please note that Regular arming can also be activated using Auto-Arming (see *Auto-Arming* on page 10) or One-Touch arming (see *One-Touch Arming* on page 9).

### How do I Regular arm?

1. Close all zones in the desired partition.
2. Press [ARM] + [ACCESS CODE].
3. If you have access to both partitions (see *Partitioning* on page 5): Press the key corresponding to the desired partition ([1] or [2]). For both partitions, press the other key after the confirmation beep.

## Sleep Arming

Similar to Stay arming, Sleep arming allows users to remain in a protected area, but provides a higher level of protection. For example, in a two-story house, the perimeter is protected with Stay arming. With Sleep arming, the perimeter as well as the main floor are protected (motion detectors, etc.), allowing you to roam the second floor and sleeping quarters. Sleep zones are zones that are bypassed when Sleep arming. For example, when you go to sleep at night, the entire premises except your bedroom is fully armed. Sleep arming can also be activated using Auto-Arming (see *Auto-Arming* on page 10) or One-Touch arming (see *One-Touch Arming* on page 9).

### How do I Sleep arm?

1. Close all zones in the desired partition (except Sleep zones).
2. Press the [SLEEP] key.
3. Enter your [ACCESS CODE].
4. If you have access to both partitions (see *Partitioning* on page 5): Press the key corresponding to the desired partition, [1] or [2]. For both partitions, press the other key after the confirmation beep.

## Stay Arming

This method allows you to roam freely within the premises while the perimeter is fully armed. Stay zones are zones that are bypassed when Stay arming. For example, if you plan on staying in for the night, doors and windows can be armed without arming other zones like motion detectors. Stay arming can also be activated using Auto-Arming (see *Auto-Arming* on page 10) or One-Touch arming (see *One-Touch Arming* on page 9).

### How do I Stay arm?

1. Close all zones in the desired partition (except Stay zones).
2. Press the [STAY] key.
3. Enter your [ACCESS CODE].
4. If you have access to both partitions (see *Partitioning* on page 5): Press the key corresponding to the desired partition, [1] or [2]. For both partitions, press the other key after the confirmation beep.

# One-Touch Arming

One-Touch arming allows you to arm the system without using an access code. This feature must be enabled by your installer.

 If One-Touch Arming is programmed, you can increase the security level of your system (from Disarm → Stay Arm → Sleep Arm → Full Arm) without a code. See Figure 4 on page 9.

## One-Touch Regular Arming

Press and hold the **[ARM]** key for 3 seconds to arm all zones in the partition. If partitioned, keys **[1]** & **[2]** will flash. You can use this feature to allow specific individuals like service personnel (e.g. cleaners) to arm without giving them access to any other alarm system operations. For details see *Regular Arming* on page 8.

## One-Touch Stay Arming

Press and hold the **[STAY]** key for 3 seconds to arm the perimeter (zones not defined as Stay zones). For details see *Stay Arming* on page 8.

## One-Touch Sleep Arming

Press and hold the **[SLEEP]** key for 3 seconds to arm all zones not defined as Sleep zones. For details see *Sleep Arming* on page 8.

## One-Touch Bypass Programming

Press and hold the **[BYP]** key for 3 seconds to access Bypass Programming Mode. For details see *Manual Bypass Programming* on page 10.

## Fast Exit

When the system is already Stay or Sleep armed: This feature will allow you to exit already armed premises and keep the system armed. Press and hold the **[OFF]** key for 3 seconds to start the exit delay. After the exit delay has elapsed, the system will switch to its previous arming mode.

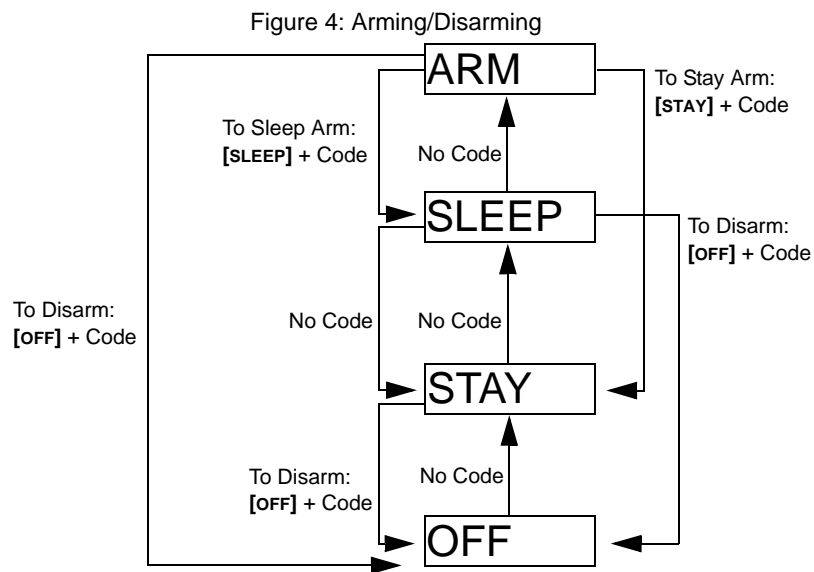

# Auto-Arming

The Magellan alarm system can be programmed to automatically arm upon the following two conditions.

## Timed Auto Arming

The alarm system can automatically arm itself at a specified time every day. As with Regular arming (see *Regular Arming* on page 8), the system will bypass any open zones. Your installer can enable this option, but you can program the time of day the system will automatically arm.

### How do I program the Auto-Arm Timer?

1. Press the [**⏻**] key.
2. Enter [**MASTER CODE**].
3. Press the [**BYP**] key. The [**BYP**] key will flash to indicate you are in the System Options menu.
4. Press key [**1**] to set partition 1, or press key [**2**] to set partition 2.
5. Enter the desired time for auto arm (24 hour clock, e.g. 18:30).
6. Press key [**1**] to regular arm, key [**2**] to sleep arm, or key [**3**] to stay arm the partition.

## No Movement Auto Arming

The alarm system can be programmed to arm the system and/or send a report if no zone activity occurs for a pre-programmed amount of time. This is a particularly useful feature when supervising an individual with chronic health problems or a person who lives alone. The system will bypass any open zones. This feature must be set by your installer.

# Disarming & Deactivating an Alarm

To disarm an armed system or an alarm, press [**OFF**] and enter your [**ACCESS CODE**]. An entry point, like the front door, will be programmed with one of two Entry Delay Timers. When an entry point is opened, the keypad will beep until you disarm the system. Your alarm system will not generate an alarm until this timer elapses. Any user can disarm a partition they have been assigned to, except users assigned with the Arm Only Option or PGM Only Option. To disarm alarms generated by a Delayed Fire Zone, refer to *Fire Alarms* on page 12.

### How do I disarm the system?

For a Stay or Sleep armed system, go to step 2.

1. Enter through a designated entry point (e.g. front door).
2. Press [**OFF**] + enter [**ACCESS CODE**].
3. If you have access to both partitions (see *Partitioning* on page 5): Press the key corresponding to the desired partition ([**1**] or [**2**]). For both partitions, press the other key after the confirmation beep.

### How do I deactivate an alarm?

Press [**OFF**] + enter [**ACCESS CODE**].

# Manual Bypass Programming

Manual Bypass Programming allows you to program the alarm system to ignore (deactivate) specified zones the next time the system is armed. For example, you may wish to bypass certain zones when workers are renovating part of your establishment. Once the system is disarmed, the bypass entries are erased. Manual Bypass Programming can also be activated by using One-Touch Bypass Programming (see the note below). To remove the Bypass feature from a zone, in step 3 enter the zone number again or press [**CLEAR**] to erase all current entries. When zones are bypassed, the [**BYP**] key will illuminate.

### How do I bypass zones?

1. Press the [**BYP**] key.
2. Enter [**ACCESS CODE**] (see the note below). The [**BYP**] key will flash.
3. Illuminate the number(s) corresponding to the zone(s) you want to bypass by entering the two-digit zone number (e.g. zone 3 = 03). Solid on = Zone open, Flash = Zone bypass, Off = Zone closed, not bypassed.
4. Press the [**ENTER**] key to save and exit.



If One-Touch Bypass Programming is enabled, press the [**BYP**] key for three seconds to enter Bypass Programming. Press [**ENTER**] after step 2 to bypass all open zones. Press [**CLEAR**] twice to exit without saving. Press [**CLEAR**] + [**ENTER**] to delete bypassed zones.

## **Bypass Recall Feature**

After disarming the system, the bypass entries are erased. The Bypass Recall feature reinstates the previous bypass entries saved in memory. This eliminates the need to manually re-program the bypass entries every time you arm the system.

### *How do I recall bypass entries?*

1. Press the **[BYP]** key
2. Enter your **[ACCESS CODE]**
3. Press the **[BYP]** key.
4. Press the **[ENTER]** key.

# System Features

## Display Mode

(MG32LRF only)

The MG32LRF has two display modes. By default, the keypad will show all events (e.g. zones in alarm, bypassed zones, etc.) live as they occur. Alternatively, the system can be programmed by your installer to only display zones that cause an alarm or entry delay. If you want to see the status of all zones, press the **[i]** key. Zones that are open but have not triggered an alarm will only be displayed after pressing the **[i]** key. The information will be displayed for 30 seconds, showing the status of all zones at the time the **[i]** key was pressed. The zone display will shut off after 30 seconds. For more information on the two display modes, contact your installer.

## Alarm Display

If an alarm has occurred on a zone, the respective zone LED will flash, the **[MEM]** key will light up, and the zones will be stored in memory. These respective LEDs will continue to flash until disarming even if the zones are restored. To exit this mode and switch to live display mode before disarming, press the **[CLEAR]** key. When the system is disarmed, the zones' LEDs will turn off, while the **[MEM]** key remains lit. Press the **[MEM]** key to illuminate the LEDs corresponding to the zones that were in alarm. The alarm memory will be erased when the next alarm occurs and after a valid code is entered.

## Fire Alarms

Upon a fire alarm, the bell/siren will emit three "squawks" at 2 second intervals until silenced or reset by entering a valid access code. If the zone is a Delayed Fire Zone, there is a delay before the system contacts the monitoring station. This will prevent unnecessary reporting of false alarms. If there is no fire condition, contact your monitoring station immediately to avoid an unnecessary response.

*What do I do if a delayed fire zone was set off accidentally?*

1. Press the **[CLEAR]** key within 30 seconds of the alarm.
2. Try to correct the problem.
3. If the problem persists, after 90 seconds, the alarm will sound again. Press the **[CLEAR]** key again.

### Minimizing Fire Hazards

The three most common causes of fires:

- Cooking is the leading cause of home fires in the U.S. It's also the leading cause of fire injuries. Cooking fires often result from unattended cooking and human error, rather than mechanical failure of stoves or ovens.
- Careless smoking is the leading cause of fire deaths. Smoke detectors and smolder-resistant bedding and upholstered furniture are significant fire deterrents.
- Heating is the second leading cause of residential fires. However, heating fires are a larger problem in single family homes than in apartments since the heating systems in single family homes are often not professionally maintained.

### Fire Safety Tips

- In the event of a fire, escape first, then call for help. Develop a home fire escape plan and designate a meeting place outside. Make sure everyone in the family knows two ways to escape from every room. Practice feeling your way out with your eyes closed. Never stand up in a fire, always crawl low under the smoke and try to keep your mouth covered. Never return to a burning building for any reason; it may cost you your life.
- Finally, having at least one working smoke alarm dramatically increases your chances of surviving a fire. And remember to practice a home escape plan frequently with your family.

### Providing a Fire Warning System

Household fires are especially dangerous at night. Fires produce smoke and deadly gases that can overcome occupants while they sleep. To warn against fire, smoke detectors should be installed outside each separate sleeping area in the immediate vicinity of the bedrooms and on each additional story of the family living unit, including basements.

## Panic Alarms

In case of an emergency, the Magellan system can provide three panic alarms that can immediately generate an alarm after simultaneously pressing and holding two specific keys for three seconds. Based on your needs, these panic alarms can generate audible alarms (sirens or bells) or silent alarms and can communicate specific messages to your monitoring station. For instance, pressing **[1]** and **[3]** can mean "call the police" or anything you require. This feature must be set by your installer.

Press and hold keys **[1]** and **[3]** for the police.

Press and hold keys **[4]** and **[6]** for a medical alarm.

Press and hold keys **[7]** and **[9]** for a fire alarm.

# Programming Chime Zones

A Chime-enabled zone will advise you every time it is opened by causing your keypad to beep.



*Each keypad must be Chimed separately.*

## How do I chime zones? **MG32LED / MG32LRF (32-zone Hardwired & Wireless LED Keypad Modules only)**

1. Press & hold the [▼] key for 3 seconds. The Arm1, Arm2, Stay1, and Stay2 LEDs will flash.
2. Select the numbers corresponding to the zones you want to Chime by entering the two-digit zone number. For example, to chime zone 2 enter [0] then [2]. The corresponding LED will light up. The keypad will automatically save the information once the 2-digit zone number is entered.
3. Press the [ENTER] key to exit.

To remove the Chime feature from a zone, in step 2 enter the zone number again so the number extinguishes or press [SLEEP] to remove Chiming from all zones programmed to Chime. Any zones that are already Chimed will also illuminate. Zones that remain unlit are not Chimed.

## How do I chime zones? **MG10LEDV / MG10LEDH (10-zone LED Keypad Modules only)**

1. Press & hold the zone key ([1] to [0(10)]) for 3 seconds. Accept beep = Chime on, Fail beep = Chime off.

# Keypad Muting

When muted, the keypad will only emit the confirmation beep, rejection beep, and beep when a key is pressed. Therefore, when muted, the keypad will not beep during an alarm and will not beep for chime enabled zones.

Press and hold the [CLEAR] key for 6 seconds to enable or disable Keypad Muting. If the keypad emits a confirmation beep, Keypad Muting is enabled for that keypad. If the keypad emits a rejection beep, the feature is disabled.



*Each keypad must be muted separately.*

# Keypad Backlight

The illumination level behind the keys can be modified to suit your needs. There are four backlight levels. The [▲] or [MEM] key is used to set the desired level. Each consecutive push of the [▲] or [MEM] key will increase the backlight level until the maximum level is reached. After reaching the maximum level, the backlight level will return to the lowest level and the whole process is repeated.

## How do I modify the backlight? **MG32LED / MG32LRF (32-zone Hardwired & Wireless LED Keypad Modules only)**

1. Press and hold the [▲] key for 3 seconds.
2. Press the [▲] key to set the desired backlight level.
3. Press [CLEAR] or [ENTER] to exit.

## How do I modify the backlight? **MG10LEDV/H (10-zone LED Keypad Modules only)**

1. Press and hold the [MEM] key for 3 seconds. The [MEM] key will illuminate.
2. Press the [MEM] key to set the desired backlight level.
3. Press [CLEAR] or [ENTER] to exit.

# PGM Keys (Programmable Outputs)

Your Magellan system may include one or more programmable outputs (PGMs). When a specific event or condition occurs in the system, The PGM can be used to reset smoke detectors, activate light switches in your home or office, open/close garage doors and much more. If programmed by your installer, you can press and hold keys [1] & [2], [2] & [3], [4] & [5], [5] & [6], [7] & [8], or [8] & [9] for each respective PGM. Press and hold [CLEAR] + [ENTER] or [⏏] for three seconds to perform a smoke reset. These features must be set by your installer.

# Power Save Mode

## (MG32LRF - Wireless Keypad Modules only)

If there is power loss on the keypad, the module's display will shut off and go into power save mode after one minute. Press the **[INFO]** key to activate the display.

## Trouble Display

 **Your alarm system continuously monitors several trouble conditions that can be reported directly to your monitoring station. When a trouble condition occurs, the **[TBL]** key will illuminate. We strongly suggest that you inform your monitoring station of the trouble and allow them to service your system.**

 **The keypad can be programmed to emit a BEEP every 5 seconds whenever a new trouble condition has occurred. Press the **[TBL]** key to stop the "Trouble Beep".**

### How do I access the Trouble Display?

1. Press the **[TBL]** key.  
*The **[TBL]** key will flash and number(s) corresponding to the trouble(s) will illuminate.*
2. Read the corresponding explanation of the trouble from the *Trouble List* below. If no repair instructions are given, call your monitoring station for repairs.
3. Press the **[CLEAR]** key to exit.

### Trouble List

**[1] Wireless Zone Low Battery:** The battery voltage in one or more wireless zones is getting low.

**[2] Power Trouble:** Five types of power trouble - **[1]** The control panel is experiencing low/no battery. **[2]** There is an AC failure on the control panel. **[3]** There is an auxiliary overload on the control panel. **[4]** A wireless keypad is experiencing AC failure. **[5]** A wireless keypad is experiencing battery failure.

**[3] Bell Trouble:** There is a bell disconnect/overload on the control panel.

**[4] Communication Trouble:** Your alarm system, if monitored, could not communicate with the monitoring station.

**[5] Tamper/Zone Wiring Failure:** A wiring problem is occurring on one or more zones.

**[6] Module Tamper Trouble:** A module's anti-tamper switch has been triggered.

**[7] Fire Loop Trouble:** Indicates a wiring trouble on a fire zone.

**[8] Timer Loss:** Your alarm system's clock must be reprogrammed. **This is the only trouble that we recommend that you correct.**

### How do I reprogram the clock?

1. Press **[8]** for Timer Loss.
2. Enter the hour and minutes. If the hour is between 01 and 12, you will need to select **[1]** for 24Hr format, **[2]** for AM, and **[3]** for PM setting. If the hour is above 12, the system will automatically select the 24Hr format.
3. Enter the year (4 digits).
4. Enter the month (2 digits).
5. Enter the day (2 digits). You have now set the Time & Date. Press **[CLEAR]** to exit.

**[9] Wireless Zone Supervision Loss:** One or more wireless zones are no longer communicating with the control panel.

**[10] Module Supervision Loss:** One or more modules are no longer communicating with the control panel.

**[16] Keypad Fault** (MG32LED/MG32LRF only): One or more keypads are no longer communicating with the control panel.

**[sleep] Keypad Fault** (MG10LEDV/H only): One or more keypads are no longer communicating with the control panel.



# Advanced Features

---

## Quick Function Keys

Upon request of your installer or monitoring station you may have to perform one of the following. To enter Menu Programming, press [⏻] and then enter your [MASTER CODE]. In Menu programming, press:

### Test Report

[MEM] + [2]

If your system is monitored by a monitoring station, this feature will send a test report code to the monitoring station.

### Call PC

[MEM] + [1]

Will initiate a call to the monitoring station that is using the WinLoad software.

### Answer PC

[MEM] + [1]

Will force your security system to answer a call made by your monitoring station that is using the WinLoad software.

### Cancel Communication

[MEM] + [9]

Cancels all communication with the WinLoad software if it has been initiated.

## Testing & Maintenance

With the system disarmed and the "OFF" light illuminated, activate motion detectors by walking in the protected area. Open and close protected doors and verify that the corresponding lights illuminate. Your installer can advise you of the best way to test your particular system.

Do not use open flame or burning materials to test your fire detection devices. Contact your installer for safe methods of testing your system.

Under normal use, your system requires virtually no maintenance other than regular testing. It is recommended that the standby battery be changed every three years. Speak to your installer about the necessary tests and how often they should be performed.

# System Checklist

Zone # and Description	Partition 1 or 2	Byp	Stay	Sleep	Force	24Hr	Entry Delay	Fire Zone/Delay
01: _____	_____	<input type="checkbox"/>	<input type="checkbox"/>	<input type="checkbox"/>	<input type="checkbox"/>	<input type="checkbox"/>	<input type="checkbox"/>	Fire Zone? Y <input type="checkbox"/> N <input type="checkbox"/> Delayed? Y <input type="checkbox"/> N <input type="checkbox"/>
02: _____	_____	<input type="checkbox"/>	<input type="checkbox"/>	<input type="checkbox"/>	<input type="checkbox"/>	<input type="checkbox"/>	<input type="checkbox"/>	Fire Zone? Y <input type="checkbox"/> N <input type="checkbox"/> Delayed? Y <input type="checkbox"/> N <input type="checkbox"/>
03: _____	_____	<input type="checkbox"/>	<input type="checkbox"/>	<input type="checkbox"/>	<input type="checkbox"/>	<input type="checkbox"/>	<input type="checkbox"/>	Fire Zone? Y <input type="checkbox"/> N <input type="checkbox"/> Delayed? Y <input type="checkbox"/> N <input type="checkbox"/>
04: _____	_____	<input type="checkbox"/>	<input type="checkbox"/>	<input type="checkbox"/>	<input type="checkbox"/>	<input type="checkbox"/>	<input type="checkbox"/>	Fire Zone? Y <input type="checkbox"/> N <input type="checkbox"/> Delayed? Y <input type="checkbox"/> N <input type="checkbox"/>
05: _____	_____	<input type="checkbox"/>	<input type="checkbox"/>	<input type="checkbox"/>	<input type="checkbox"/>	<input type="checkbox"/>	<input type="checkbox"/>	Fire Zone? Y <input type="checkbox"/> N <input type="checkbox"/> Delayed? Y <input type="checkbox"/> N <input type="checkbox"/>
06: _____	_____	<input type="checkbox"/>	<input type="checkbox"/>	<input type="checkbox"/>	<input type="checkbox"/>	<input type="checkbox"/>	<input type="checkbox"/>	Fire Zone? Y <input type="checkbox"/> N <input type="checkbox"/> Delayed? Y <input type="checkbox"/> N <input type="checkbox"/>
07: _____	_____	<input type="checkbox"/>	<input type="checkbox"/>	<input type="checkbox"/>	<input type="checkbox"/>	<input type="checkbox"/>	<input type="checkbox"/>	Fire Zone? Y <input type="checkbox"/> N <input type="checkbox"/> Delayed? Y <input type="checkbox"/> N <input type="checkbox"/>
08: _____	_____	<input type="checkbox"/>	<input type="checkbox"/>	<input type="checkbox"/>	<input type="checkbox"/>	<input type="checkbox"/>	<input type="checkbox"/>	Fire Zone? Y <input type="checkbox"/> N <input type="checkbox"/> Delayed? Y <input type="checkbox"/> N <input type="checkbox"/>
09: _____	_____	<input type="checkbox"/>	<input type="checkbox"/>	<input type="checkbox"/>	<input type="checkbox"/>	<input type="checkbox"/>	<input type="checkbox"/>	Fire Zone? Y <input type="checkbox"/> N <input type="checkbox"/> Delayed? Y <input type="checkbox"/> N <input type="checkbox"/>
10: _____	_____	<input type="checkbox"/>	<input type="checkbox"/>	<input type="checkbox"/>	<input type="checkbox"/>	<input type="checkbox"/>	<input type="checkbox"/>	Fire Zone? Y <input type="checkbox"/> N <input type="checkbox"/> Delayed? Y <input type="checkbox"/> N <input type="checkbox"/>
11: _____	_____	<input type="checkbox"/>	<input type="checkbox"/>	<input type="checkbox"/>	<input type="checkbox"/>	<input type="checkbox"/>	<input type="checkbox"/>	Fire Zone? Y <input type="checkbox"/> N <input type="checkbox"/> Delayed? Y <input type="checkbox"/> N <input type="checkbox"/>
12: _____	_____	<input type="checkbox"/>	<input type="checkbox"/>	<input type="checkbox"/>	<input type="checkbox"/>	<input type="checkbox"/>	<input type="checkbox"/>	Fire Zone? Y <input type="checkbox"/> N <input type="checkbox"/> Delayed? Y <input type="checkbox"/> N <input type="checkbox"/>
13: _____	_____	<input type="checkbox"/>	<input type="checkbox"/>	<input type="checkbox"/>	<input type="checkbox"/>	<input type="checkbox"/>	<input type="checkbox"/>	Fire Zone? Y <input type="checkbox"/> N <input type="checkbox"/> Delayed? Y <input type="checkbox"/> N <input type="checkbox"/>
14: _____	_____	<input type="checkbox"/>	<input type="checkbox"/>	<input type="checkbox"/>	<input type="checkbox"/>	<input type="checkbox"/>	<input type="checkbox"/>	Fire Zone? Y <input type="checkbox"/> N <input type="checkbox"/> Delayed? Y <input type="checkbox"/> N <input type="checkbox"/>
15: _____	_____	<input type="checkbox"/>	<input type="checkbox"/>	<input type="checkbox"/>	<input type="checkbox"/>	<input type="checkbox"/>	<input type="checkbox"/>	Fire Zone? Y <input type="checkbox"/> N <input type="checkbox"/> Delayed? Y <input type="checkbox"/> N <input type="checkbox"/>
16: _____	_____	<input type="checkbox"/>	<input type="checkbox"/>	<input type="checkbox"/>	<input type="checkbox"/>	<input type="checkbox"/>	<input type="checkbox"/>	Fire Zone? Y <input type="checkbox"/> N <input type="checkbox"/> Delayed? Y <input type="checkbox"/> N <input type="checkbox"/>
17: _____	_____	<input type="checkbox"/>	<input type="checkbox"/>	<input type="checkbox"/>	<input type="checkbox"/>	<input type="checkbox"/>	<input type="checkbox"/>	Fire Zone? Y <input type="checkbox"/> N <input type="checkbox"/> Delayed? Y <input type="checkbox"/> N <input type="checkbox"/>
18: _____	_____	<input type="checkbox"/>	<input type="checkbox"/>	<input type="checkbox"/>	<input type="checkbox"/>	<input type="checkbox"/>	<input type="checkbox"/>	Fire Zone? Y <input type="checkbox"/> N <input type="checkbox"/> Delayed? Y <input type="checkbox"/> N <input type="checkbox"/>
19: _____	_____	<input type="checkbox"/>	<input type="checkbox"/>	<input type="checkbox"/>	<input type="checkbox"/>	<input type="checkbox"/>	<input type="checkbox"/>	Fire Zone? Y <input type="checkbox"/> N <input type="checkbox"/> Delayed? Y <input type="checkbox"/> N <input type="checkbox"/>
20: _____	_____	<input type="checkbox"/>	<input type="checkbox"/>	<input type="checkbox"/>	<input type="checkbox"/>	<input type="checkbox"/>	<input type="checkbox"/>	Fire Zone? Y <input type="checkbox"/> N <input type="checkbox"/> Delayed? Y <input type="checkbox"/> N <input type="checkbox"/>
21: _____	_____	<input type="checkbox"/>	<input type="checkbox"/>	<input type="checkbox"/>	<input type="checkbox"/>	<input type="checkbox"/>	<input type="checkbox"/>	Fire Zone? Y <input type="checkbox"/> N <input type="checkbox"/> Delayed? Y <input type="checkbox"/> N <input type="checkbox"/>
22: _____	_____	<input type="checkbox"/>	<input type="checkbox"/>	<input type="checkbox"/>	<input type="checkbox"/>	<input type="checkbox"/>	<input type="checkbox"/>	Fire Zone? Y <input type="checkbox"/> N <input type="checkbox"/> Delayed? Y <input type="checkbox"/> N <input type="checkbox"/>
23: _____	_____	<input type="checkbox"/>	<input type="checkbox"/>	<input type="checkbox"/>	<input type="checkbox"/>	<input type="checkbox"/>	<input type="checkbox"/>	Fire Zone? Y <input type="checkbox"/> N <input type="checkbox"/> Delayed? Y <input type="checkbox"/> N <input type="checkbox"/>
24: _____	_____	<input type="checkbox"/>	<input type="checkbox"/>	<input type="checkbox"/>	<input type="checkbox"/>	<input type="checkbox"/>	<input type="checkbox"/>	Fire Zone? Y <input type="checkbox"/> N <input type="checkbox"/> Delayed? Y <input type="checkbox"/> N <input type="checkbox"/>
25: _____	_____	<input type="checkbox"/>	<input type="checkbox"/>	<input type="checkbox"/>	<input type="checkbox"/>	<input type="checkbox"/>	<input type="checkbox"/>	Fire Zone? Y <input type="checkbox"/> N <input type="checkbox"/> Delayed? Y <input type="checkbox"/> N <input type="checkbox"/>
26: _____	_____	<input type="checkbox"/>	<input type="checkbox"/>	<input type="checkbox"/>	<input type="checkbox"/>	<input type="checkbox"/>	<input type="checkbox"/>	Fire Zone? Y <input type="checkbox"/> N <input type="checkbox"/> Delayed? Y <input type="checkbox"/> N <input type="checkbox"/>
27: _____	_____	<input type="checkbox"/>	<input type="checkbox"/>	<input type="checkbox"/>	<input type="checkbox"/>	<input type="checkbox"/>	<input type="checkbox"/>	Fire Zone? Y <input type="checkbox"/> N <input type="checkbox"/> Delayed? Y <input type="checkbox"/> N <input type="checkbox"/>
28: _____	_____	<input type="checkbox"/>	<input type="checkbox"/>	<input type="checkbox"/>	<input type="checkbox"/>	<input type="checkbox"/>	<input type="checkbox"/>	Fire Zone? Y <input type="checkbox"/> N <input type="checkbox"/> Delayed? Y <input type="checkbox"/> N <input type="checkbox"/>
29: _____	_____	<input type="checkbox"/>	<input type="checkbox"/>	<input type="checkbox"/>	<input type="checkbox"/>	<input type="checkbox"/>	<input type="checkbox"/>	Fire Zone? Y <input type="checkbox"/> N <input type="checkbox"/> Delayed? Y <input type="checkbox"/> N <input type="checkbox"/>
30: _____	_____	<input type="checkbox"/>	<input type="checkbox"/>	<input type="checkbox"/>	<input type="checkbox"/>	<input type="checkbox"/>	<input type="checkbox"/>	Fire Zone? Y <input type="checkbox"/> N <input type="checkbox"/> Delayed? Y <input type="checkbox"/> N <input type="checkbox"/>
31: _____	_____	<input type="checkbox"/>	<input type="checkbox"/>	<input type="checkbox"/>	<input type="checkbox"/>	<input type="checkbox"/>	<input type="checkbox"/>	Fire Zone? Y <input type="checkbox"/> N <input type="checkbox"/> Delayed? Y <input type="checkbox"/> N <input type="checkbox"/>
32: _____	_____	<input type="checkbox"/>	<input type="checkbox"/>	<input type="checkbox"/>	<input type="checkbox"/>	<input type="checkbox"/>	<input type="checkbox"/>	Fire Zone? Y <input type="checkbox"/> N <input type="checkbox"/> Delayed? Y <input type="checkbox"/> N <input type="checkbox"/>

## Zone Description

Is this system partitioned? Yes  No   
 Partition 1 = \_\_\_\_\_  
 Partition 2 = \_\_\_\_\_

## Panic Alarms

[1] & [3] Police or \_\_\_\_\_  Silent  Audible  Off  
 [4] & [6] Aux. or \_\_\_\_\_  Silent  Audible  Off  
 [7] & [9] Fire or \_\_\_\_\_  Silent  Audible  Off

## PGMs

PGM 1 _____	PGM 5 _____	PGM 9 _____	PGM 13 _____
PGM 2 _____	PGM 6 _____	PGM 10 _____	PGM 14 _____
PGM 3 _____	PGM 7 _____	PGM 11 _____	PGM 15 _____
PGM 4 _____	PGM 8 _____	PGM 12 _____	PGM 16 _____

## PGM Utility Keys

[1] & [2]: \_\_\_\_\_ [2] & [3]: \_\_\_\_\_  
 [4] & [5]: \_\_\_\_\_ [5] & [6]: \_\_\_\_\_  
 [7] & [8]: \_\_\_\_\_ [8] & [9]: \_\_\_\_\_

[CLEAR] + [ENTER] = Smoke Reset

## System Timers

Enter and exit your premises through the designated doors.

Exit Delay 1 (Partition 1): \_\_\_\_\_ sec. = time to exit premises

Exit Delay 2 (Partition 2): \_\_\_\_\_ sec. = time to exit premises

Entry Delay 1 = \_\_\_\_\_ sec. = time to disarm before alarm; enter through zone # \_\_\_\_\_

Entry Delay 2 = \_\_\_\_\_ sec. = time to disarm before alarm; enter through zone # \_\_\_\_\_

Alarm will activate siren or bell for \_\_\_\_\_ min.

## Other Information

Installed by: \_\_\_\_\_ Date: \_\_\_\_\_

Serviced by: \_\_\_\_\_ Tel: \_\_\_\_\_

Monitored by: \_\_\_\_\_ Tel: \_\_\_\_\_

Your account number: \_\_\_\_\_

Alarm transformer location: \_\_\_\_\_ on circuit #: \_\_\_\_\_

Location of Telephone Connections: \_\_\_\_\_

## Special Keys and Features

- [ARM] One-Touch Regular arming is activated
- [STAY] One-Touch Stay arming is activated
- [SLEEP] One-Touch Sleep arming is activated
- [BYP] One-Touch Manual Bypass Programming is activated

## Warranty

Paradox Security Systems Ltd. ("Seller") warrants its products to be free from defects in materials and workmanship under normal use for a period of one year. Except as specifically stated herein, all express or implied warranties whatsoever, statutory or otherwise, including without limitation, any implied warranty of merchantability and fitness for a particular purpose, are expressly excluded. Because Seller does not install or connect the products and because the products may be used in conjunction with products not manufactured by Seller, Seller cannot guarantee the performance of the security system and shall not be responsible for circumstances resulting from the product's inability to operate. Seller obligation and liability under this warranty is expressly limited to repairing or replacing, at Seller's option, any product not meeting the specifications. Returns must include proof of purchase and be within the warranty period. In no event shall the Seller be liable to the buyer or any other person for any loss or damages whether direct or indirect or consequential or incidental, including without limitation, any damages for lost profits, stolen goods, or claims by any other party, caused by defective goods or otherwise arising from the improper, incorrect or otherwise faulty installation or use of the merchandise sold.

Notwithstanding the preceding paragraph, the Seller's maximum liability will be strictly limited to the purchase price of the defective product. Your use of this product signifies your acceptance of this warranty.

BEWARE: Dealers, installers and/or others selling the product are not authorized to modify this warranty or make additional warranties that are binding on the Seller.

## Limitations of Alarm Systems

We strongly advise that you review and take into consideration the "Limitations of Alarm Systems" document available on our website at <http://paradox.com/Terms/>.

## Warning for Connections to Non-Traditional Telephony (e.g. VoIP)

Paradox alarm equipment was designed to work effectively around traditional telephone systems. For those customers who are using a Paradox alarm panel connected to a non-traditional telephone system, such as "Voice Over Internet Protocol" (VoIP) that converts the voice signal from your telephone to a digital signal traveling over the internet, you should be aware that your alarm system may not function as effectively as with traditional telephone systems.

For example, if your VoIP equipment has no battery back-up, during a power failure your system's ability to transmit signals to the central station may be compromised. Or, if your VoIP connection becomes disabled, your telephone line monitoring feature may also be compromised. Other concerns would include, without limitation, Internet connection failures which may be more frequent than regular telephone line outages.

We therefore strongly recommend that you discuss these and other limitations involved with operating an alarm system on a VoIP or other non-traditional telephone system with your installation company. They should be able to offer or recommend measures to reduce the risks involved and give you a better understanding.

## WARNINGS: Information to User

This equipment has been tested and found to comply with the limits for Class B digital devices, pursuant to Part 15 of FCC rules. These limits are designed to provide reasonable protection against harmful interference in a residential installation. This equipment generates, uses and can radiate radio frequency energy, and, if not installed and used in accordance with the instructions, may cause harmful interference to radio communications. However, there is no guarantee that interference will not occur in a particular installation. If this equipment does cause harmful interference to equipment intermittently, the user is encouraged to try to correct the interference by one or more of the following measures: (1) re orient or relocate the receiving antenna; (2) increase the separation between the equipment and receiver; (3) connect the equipment to an outlet on a circuit other than the one to which the receiver is connected, or (4) consult the dealer or an experienced radio/tv technician for assistance. CAUTION: The user is cautioned that any changes or modifications not expressly approved by Paradox Security Systems could void the user's authority to operate/use the equipment.

## Legal

© 2004-2007 Paradox Security Systems Ltd. All rights reserved. Specifications may change without prior notice. One or more of the following US patents may apply: 6215399, 6111256, 5751803, 5721542, 5287111, 5119069, 5077549, 5920259, 5886632. Canadian and international patents may also apply. Magellan is a trademark or registered trademark of Paradox Security Systems Ltd. or its affiliates in Canada, the United States and/or other countries.

**P**  **R**  **D O X**<sup>®</sup>  
**S E C U R I T Y S Y S T E M S**

[paradox.com](http://paradox.com)

Printed in Canada - 01/2007

MG5000-EU05